

0.050 FC

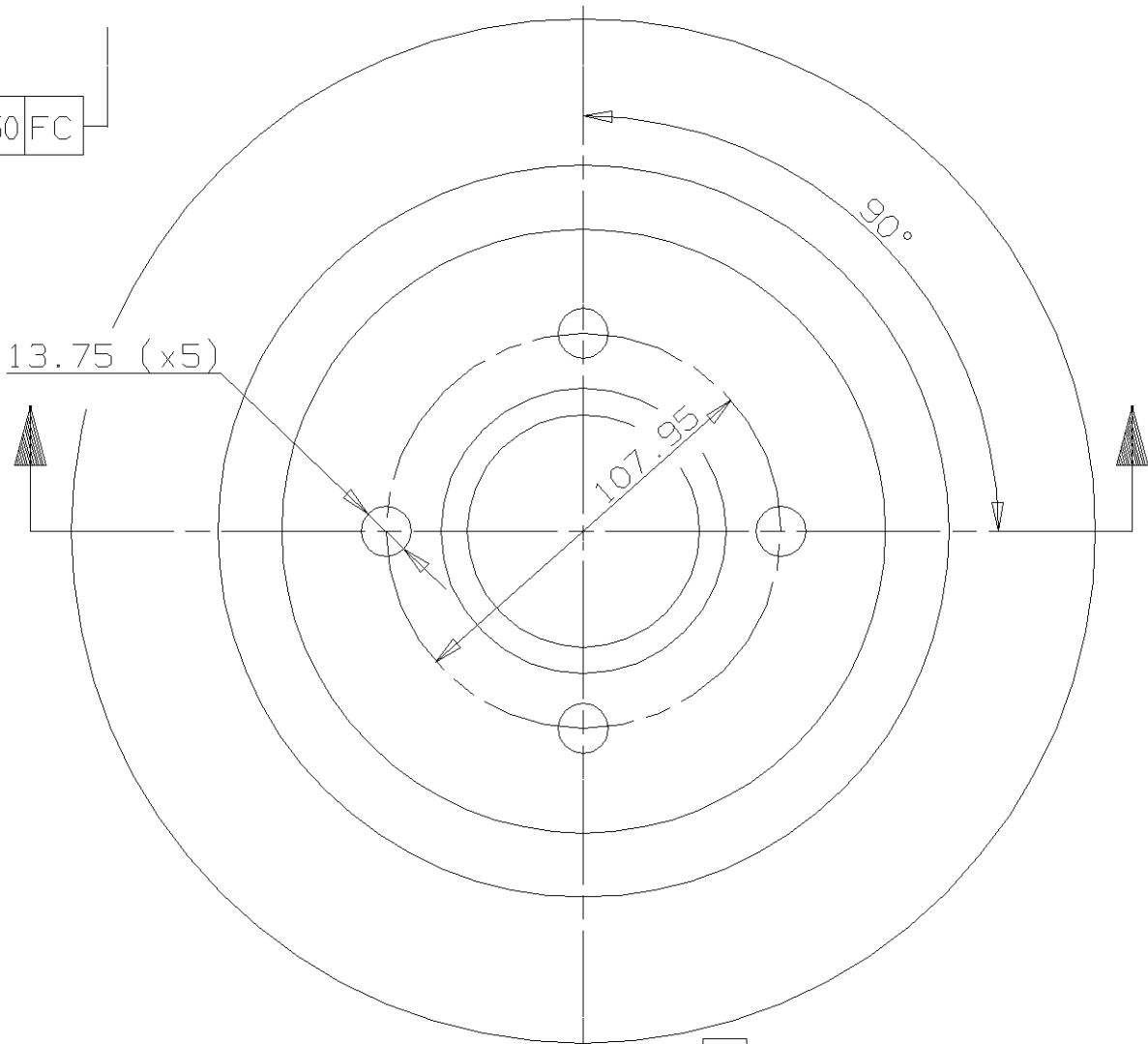

MOUNTING FACE

Min. TH 8 mm

Weight 4 Kg

Type DP